

# 1 ROOF DUCTS

Roof terminal

## THFV250-900

### THFV250-900, roof terminal for outdoor air intake

Roof terminal for vertical air intake – used as end of the duct system above the roof. Attractive design, easy installation and low-noise design



#### PRODUCT BENEFITS

- Modern design
- Easy fitting
- Low-noise design

#### Product description

EXHAUSTO roof terminal THFV is for outdoor air intakes.

The roof terminals are for use where an architecturally attractive and technically sound roof termination is required for duct systems. The roof terminals are easy to mount on different roofing constructions.

The low-noise design makes them particularly suitable for built-up areas with high environmental requirements.

#### Dimensional data

C1	250
L (mm)	900
L1 (mm)	1135
Ø C (mm)	370
Empty weight (kg)	19

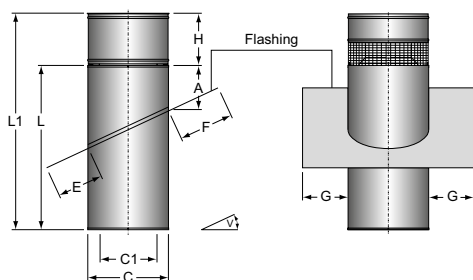

Roof terminal

**THFV250-900**

**THFV250-900, roof terminal for outdoor air intake**

**Installation**

Dimensions E, F and G apply only to PERFORM flashing.  
With zinc, the flashing is always 100 mm.

PERFORM flashing can cater for +/- 2.5° relative to the given roof pitch.

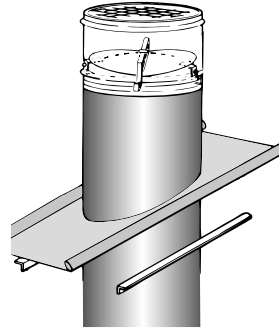
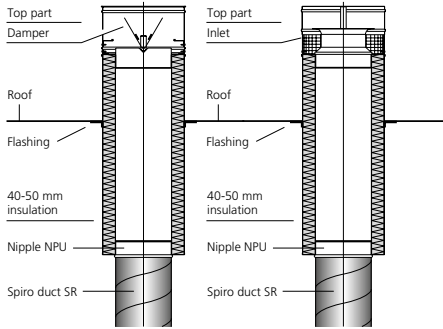

THFV roof terminals are for outdoor air intakes with a round inlet, giving minimal pressure drop. THFV has an integrated bird net.

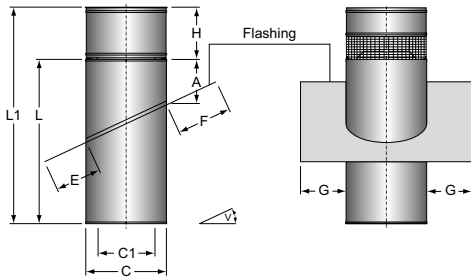
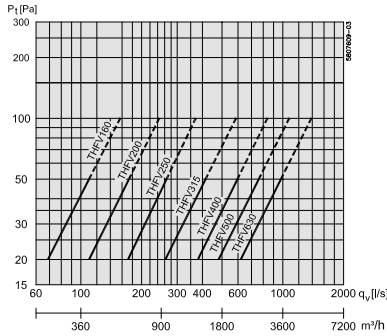

Dimensions E, F and G apply only to PERFORM flashing.  
With zinc, the flashing is always 100 mm

PERFORM flashing can cater for +/- 2.5° relative to the given roof pitch.

Roof terminal

# THFV250-900

THFV250-900, roof terminal for outdoor air intake

Curve

