

Roof terminal

THAV630-1200

THAV630-1200, roof terminal with vertical exhaust

Roof terminal for vertical exhaust – used as end of the duct system above the roof. Attractive design, easy installation and low-noise design



PRODUCT BENEFITS

- Modern design
- Easy fitting
- Low-noise design

Product description

EXHAUSTO roof terminal THAV is for air exhausts.

The roof terminals are for use where an architecturally attractive and technically sound roof termination is required for duct systems. The roof terminals are easy to mount on different roofing constructions.

The low-noise design makes them particularly suitable for built-up areas with high environmental requirements.

THAV's vertical air exhaust prevents polluted exhaust air from being deposited over surrounding areas or soiling the roof surface.

Dimensional data

C1	630
L (mm)	1200
L1 (mm)	1850
Ø C (mm)	738
Empty weight (kg)	61

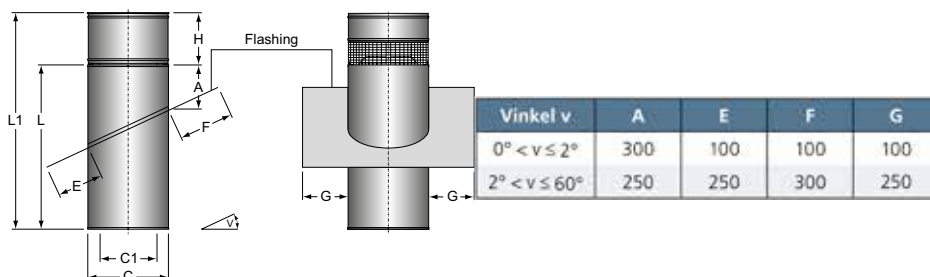

Roof terminal

THAV630-1200

THAV630-1200, roof terminal with vertical exhaust

Installation

Dimensions E, F and G apply only to PERFORM flashing.
With zinc, the flashing is always 100 mm.

PERFORM flashing can cater for +/- 2.5° relative to the given roof pitch.

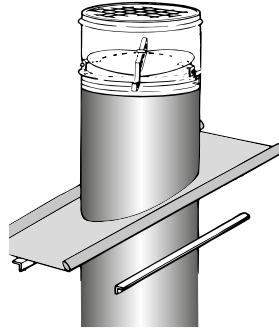
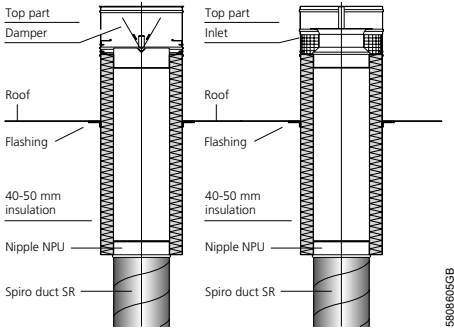

THAV roof terminal is for vertical exhaust and has a built-in damper. A bird protection net is mounted at the top to prevent unwanted objects from entering the duct system.

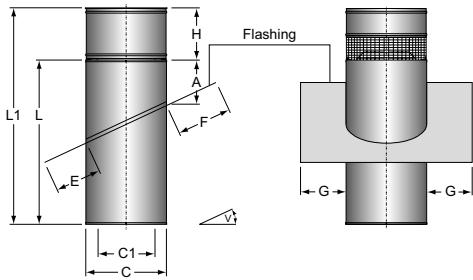
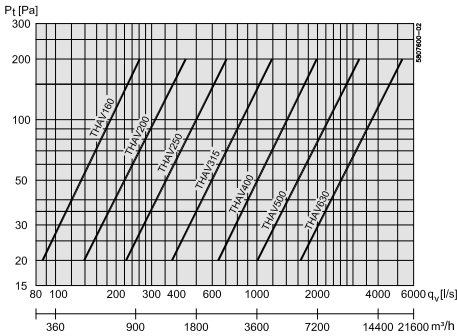

Dimensions E, F and G apply only to PERFORM flashing.
With zinc, the flashing is always 100 mm

PERFORM flashing can cater for +/- 2.5° relative to the given roof pitch.

Roof terminal

THAV630-1200

THAV630-1200, roof terminal with vertical exhaust

Curve

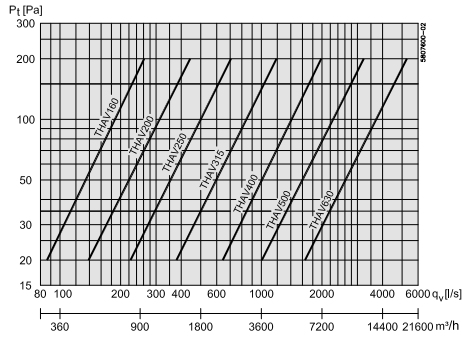

THAV fue gas resistance
 If the duct system has smoke ventilation, e.g. in apartment buildings, flue gas resistance in the duct system must be calculated from the following diagram. The THFV roof terminal has a fixed flue gas resistance.

THAV has an integral stop plate for insertion for smoke ventilation.